

Viewing the Connection Panel

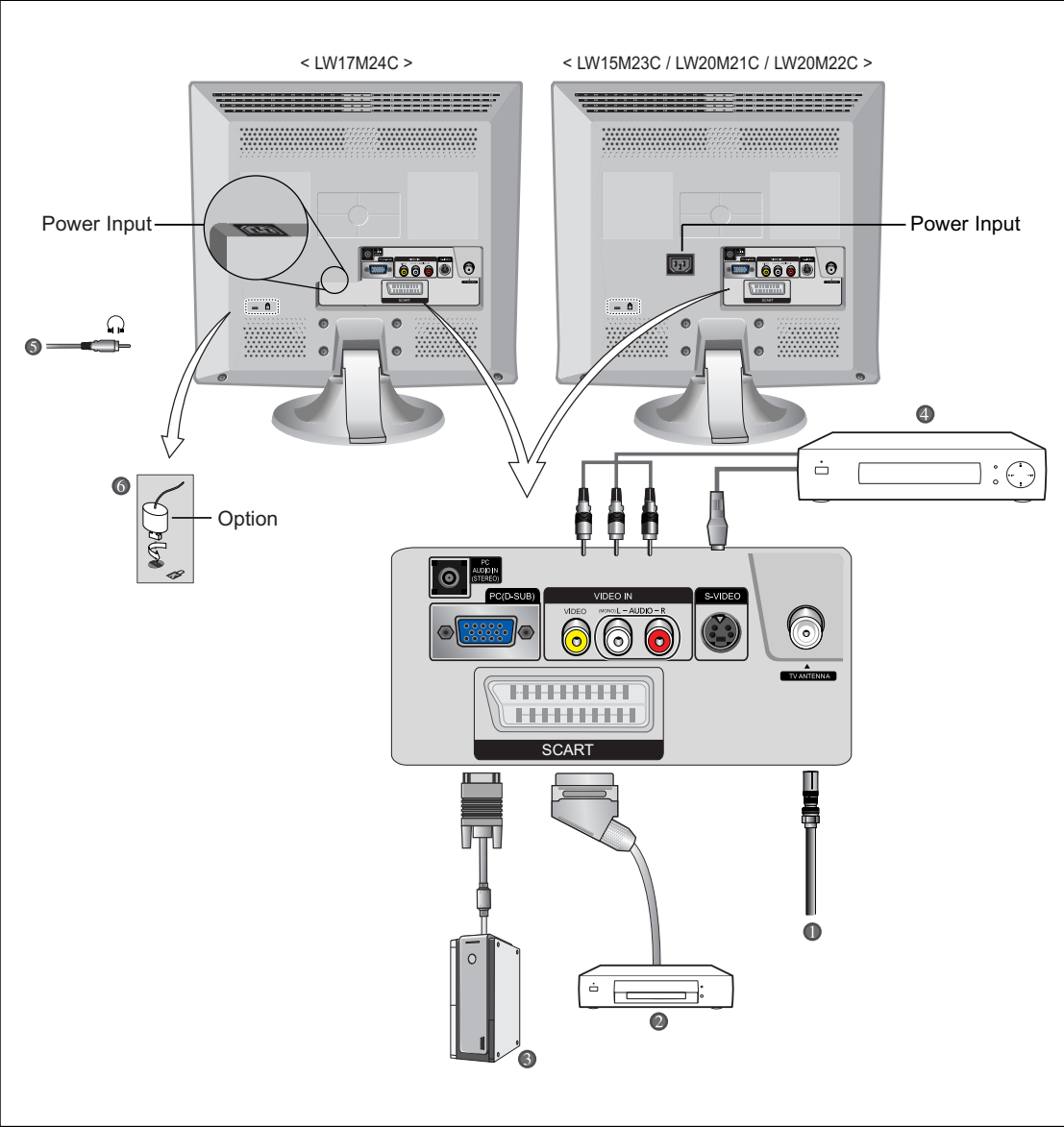

Whenever you connect an audio or video system to your set, ensure that all elements are switched off. Refer to the documentation supplied with your equipment for detailed connection instructions and associated safety precautions.

Viewing the Connection Panel

❶ **Connecting an Aerial or Cable Television Network (depending on the model)**

To view television channels correctly, a signal must be received by the set from one of the following sources:

- An outdoor aerial
- A cable television network
- A satellite network

❷ **Connecting a Set-Top Box, VCR or DVD**

- Connect the VCR, or DVD SCART cable to the SCART connector of the VCR, or DVD.
- If you wish to connect both the Set-Top Box and VCR (or DVD), you should connect the Set-Top Box to the VCR (or DVD) and connect the VCR (or DVD) to your set.

❸ **Connecting a Computer**

- Connect the 15 Pin D-SUB connector to the PC video connector.
- Connect the stereo audio cable to the "Audio (ST)" jack on the rear of your set and the other end to the "Audio Out" jack of the sound card on your computer.

➤ 15 Pin D-SUB connector

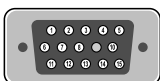

| Pin | Separate H/V | Composite H/V |
|-----|-------------------------------|-------------------------------|
| 1 | Red (R) | Red (R) |
| 2 | Green (G) | Green (G) |
| 3 | Blue (B) | Blue (B) |
| 4 | Grounding | Grounding |
| 5 | Grounding (DDC return) | Grounding (DDC return) |
| 6 | Grounding - Red (R) | Grounding - Red (R) |
| 7 | Grounding - Green (G) | Grounding - Green (G) |
| 8 | Grounding - Blue (B) | Grounding - Blue (B) |
| 9 | No connection | No connection |
| 10 | Grounding - Sync. / Self test | Grounding - Sync. / Self test |
| 11 | Grounding | Grounding |
| 12 | DDC - SDA (Data) | DDC - SDA (Data) |
| 13 | Horizontal Sync. | Horizontal/Vertical Sync. |
| 14 | Vertical Sync. | Not used |
| 15 | DDC - SCL (Clock) | DDC - SCL (Clock) |

Viewing the Connection Panel

4 Connecting External A/V Devices

- Connect RCA or S-VIDEO cables to an appropriate external A/V device such as a VCR, DVD or Camcorder.
- Connect RCA audio cables to "(MONO)L-AUDIO-R" on the rear of your set and the other ends to corresponding audio out connectors on the A/V device.

5 Connecting Headphones

- Plug a set of headphones into the 3.5mm mini-jack socket on the right-side of the set.
- Headphones may be connected to the headphone output on the right-side of the set.
While the headphones are connected, the sound from the built-in speakers will be disabled.

6 Kensington Slot

- This television has been designed to apply a burglarproof lock.(See next page.)

➤ Retractable Stand

Note: The maximum tilt angle is 13 degrees in the backward direction.

Please do not tilt the TV outside the specified range. Using excessive force to tilt the TV may cause permanent damage to the mechanical part of the stand.
< LW20M21C / LW20M22C > model swivels left and right.



< LW15M23C / LW17M24C >



< LW20M21C / LW20M22C >

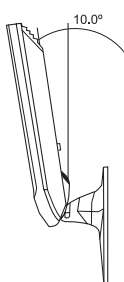
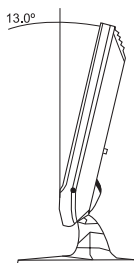

Using the Anti-Theft Kensington Lock

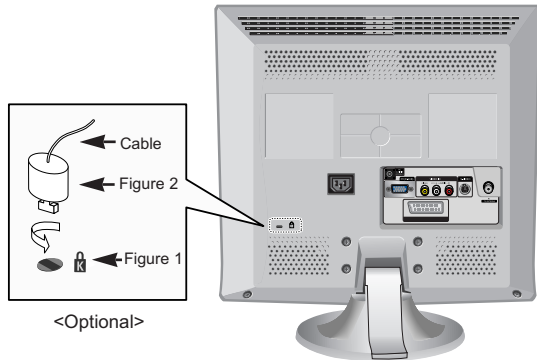

The Kensington lock is a device used to physically fix the system when using it in a public place. The locking device has to be purchased separately.

The appearance and locking method may differ from the illustration depending on the manufacturer. Please refer to the manual provided with the Kensington lock for proper use.

1. Insert the locking device into the Kensington slot on the LCD TV (Figure 1), and turn it in the locking direction (Figure 2).
2. Connect the Kensington lock cable.
3. Fix the Kensington lock to a desk or a heavy stationary object.

Installing VESA compliant mounting devices

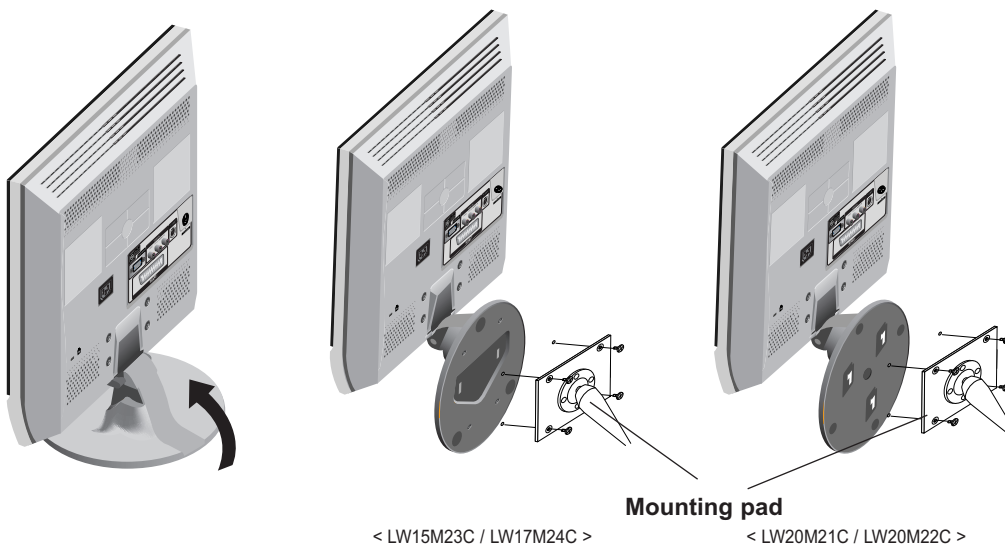

Align the mounting interface pad with the holes in the rear cover mounting pad and secure it with the four screws that come with the arm-type base, wall mount hanger or other bases.

Installing the Wall Mount Kit

Note : This installation is to be used when attaching the wall mount to a concrete wall.
When attaching to other building materials, please contact your nearest dealer.

Components

Please use provided components or parts to install the Wall Mount Kit.

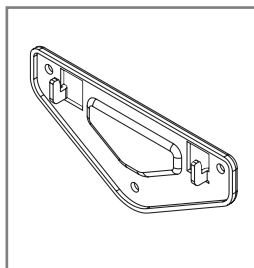

Bracket

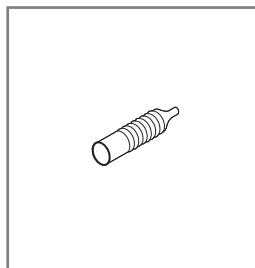

Anchors : 3EA

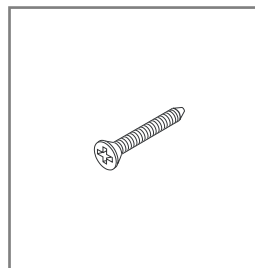

Screws : 3EA

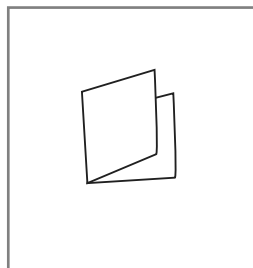

Installation Guide

How to assemble the Wall Mount Kit

- 1
 - ① Mark the location of hole on the wall using installation guide.
 - ② Make over 35mm- depth- hole on the marked location using 5.0-diameter drill.
 - ③ Fix anchors on each hole on the wall.
 - ④ Connect bracket to the wall with screws after fitting anchors into the bracket holes.

Note : If the bracket is not firmly fixed to the wall, LCD TV can fall off.

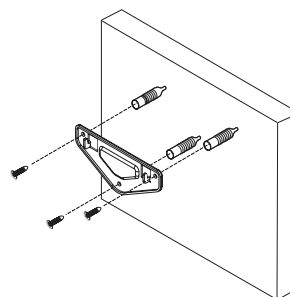

- 2 After placing LCD TV on cushion or other soft material, turn over LCD TV in the direction of arrow while grabbing bottom of the stand.

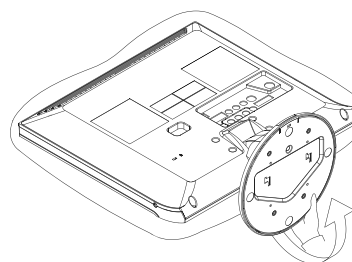

Installing the Wall Mount Kit

- 3** Adjust LCD TV to the hook on the bracket and move in the direction of the arrow(Left) so that LCD TV can be completely fixed to the bracket.

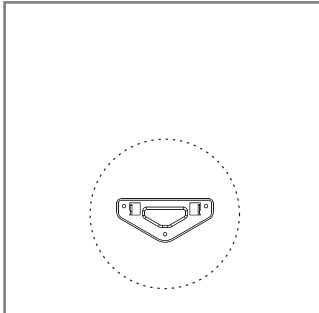

When bracket is assembled on the wall

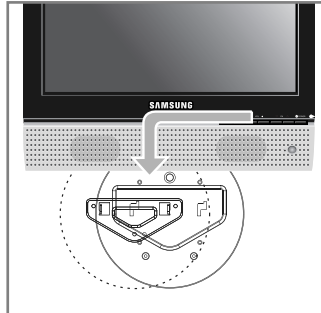

How to hang LCD TV up on a hook

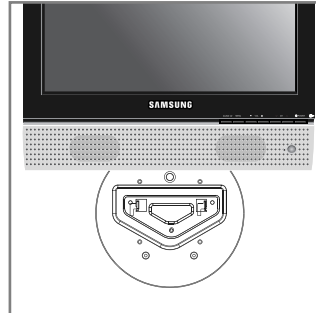

When installation is completed

- 4** Remove Installation Guide after completing setup of monitor on the wall.
- 5** Push the LCD TV up and shift to the right to detach it from bracket. When moving or transferring to other areas, reverse No. 3 procedure so as to disconnect LCD TV with ease.

How to assemble the Wall Mount Kit

(1) Angle adjustment section of general stand-based LCD TV

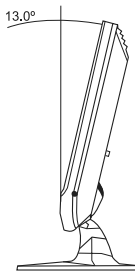

(2) Angle adjustment section while converting the form (1->3, 3->1)

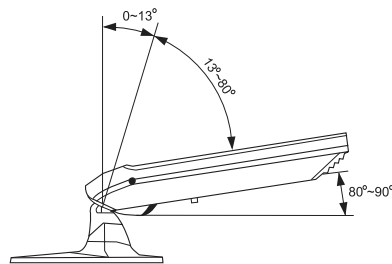

(3) Angle adjustment section of wall-mounted LCD TV

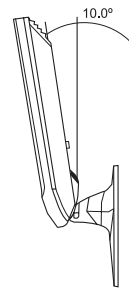

- 1** Picture(1) shows the adjustment angle(0~ 13°)when you use LCD TV in its general form(stand-based LCD TV). Excessive tilting can turn LCD TV over which might cause damage to LCD TV.
- 2** Picture(2) shows the adjustment angle(13°~ 80°)when you convert stand-based LCD TV into wall-mounted one.
- 3** Picture(3) shows the adjustment angle(0°~ 10°)when you use wall-mounted LCD TV after fixing it to wall.

Note : Picture (2) shows the angle adjustment section while LCD TV is being converted from stand-based one to wall-mounted one or vice versa.

- Click" sound indicates section change from 1 to 2 or 3 to 2(1->2, 3->2).

Installing the Wall Mount Kit

Note : This installation is to be used when attaching the wall mount to a concrete wall.
When attaching to other building materials, please contact your nearest dealer.

Components

Please use provided components or parts to install the Wall Mount Kit.

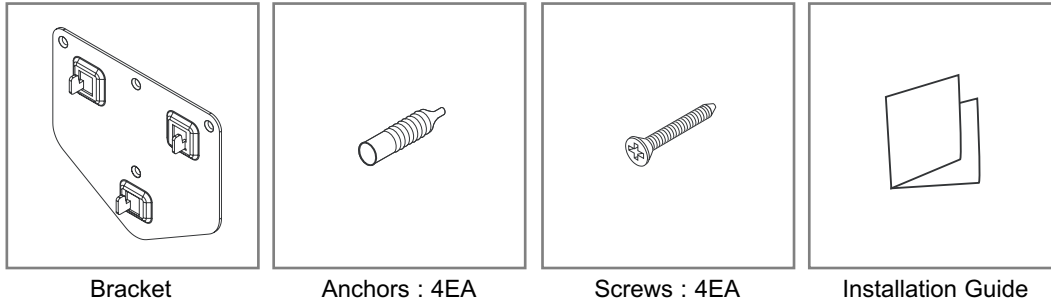

How to assemble the Wall Mount Kit

- Mark the location of hole on the wall using installation guide.
 - Make over 35mm- depth- hole on the marked location using 5.0-diameter drill.
 - Fix anchors on each hole on the wall.
 - Connect bracket to the wall with screws after fitting anchors into the bracket holes.

Note : If the bracket is not firmly fixed to the wall, LCD TV can fall off.

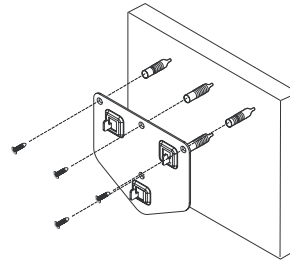

- You may use LCD TV right after fixing it to the wall since stand is wrapped already turned over as shown in the picture

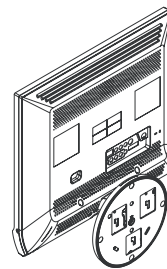

- When using LCD TV in stand-based form, place the product on a cushion or other soft materials. Then turn over stand following the arrow direction below only after pressing button on the connected part where LCD TV is attached to stand. (Turn over stand in the opposite direction after pressing button when using LCD TV in wall-mounted form as well.)

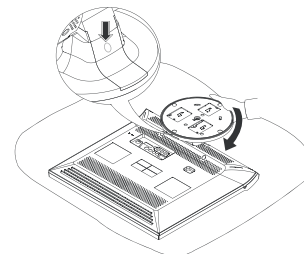

Installing the Wall Mount Kit

- 4** Adjust LCD TV to the hook on the bracket and move in the direction of the arrow(Left) so that LCD TV can be completely fixed to the bracket.

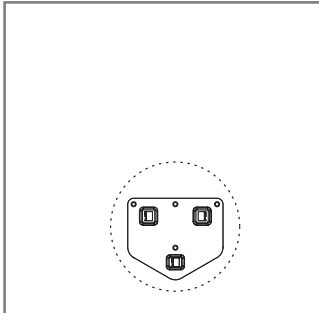

When bracket is assembled on the wall

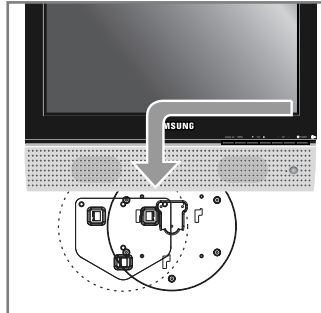

How to hang monitor up on a hook

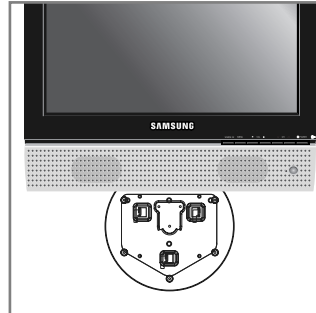

When installation is completed

- 5** Remove Installation Guide after completing setup of LCD TV on the wall.
- 6** Push the LCD TV up and shift to the right to detach it from bracket.
When moving or transferring to other areas, reverse No. 4 procedure so as to disconnect LCD TV with ease.

How to adjust an angle

- (1) Angle adjustment section of general stand-besd LCD TV

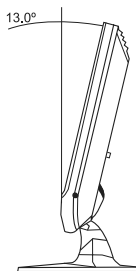

- (2) Angle abjstment section while converting the form (1->3, 3->1)

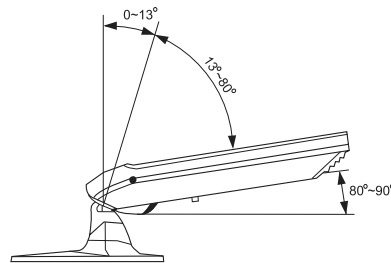

- (3) Angle adjustment section of wall-mounted LCD TV

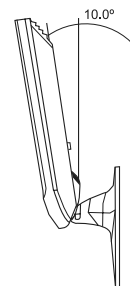

- 1** Picture(1) shows the adjustment angle(0°~ 13°)when you use LCD TV in its general form(stand-based LCD TV). Excessive tilting can turn LCD TV over which might cause damage to LCD TV.
- 2** Picture(2) shows the adjustment angle(13°~ 80°)when you convert stand-based LCD TV into wall-mounted one.
- 3** Picture(3) shows the adjustment angle(0°~ 10°)when you use wall-mounted LCD TV after fixing it to wall.

Note : Picture (2) shows the angle adjustment section while LCD TV is being converted from stand-based one to wall-mounted one or vice versa.